

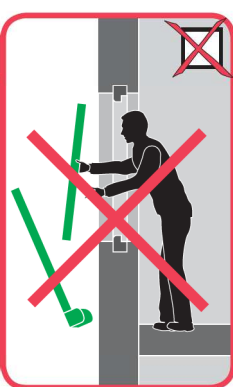

# VMZ WiFi

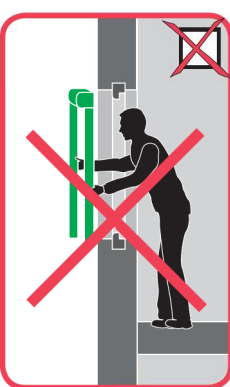
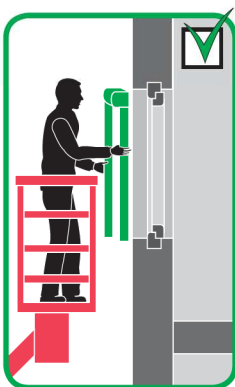
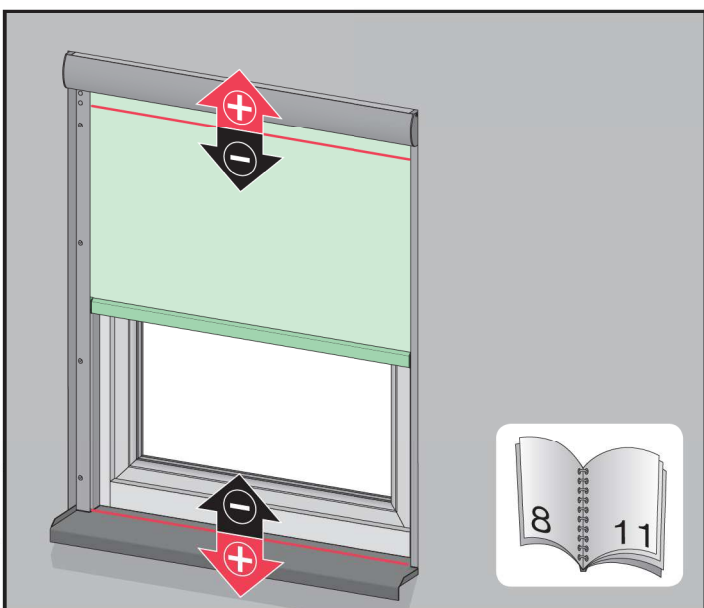
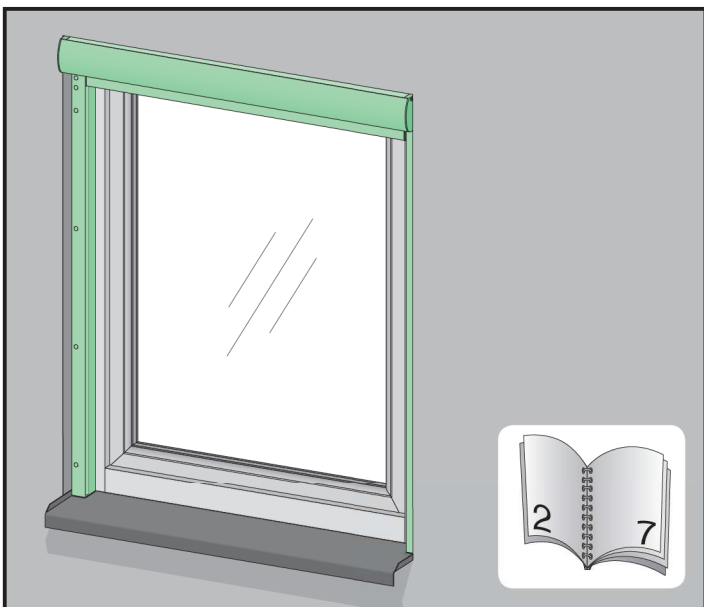

ANDROID  
iOS

wBox



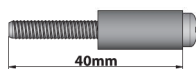
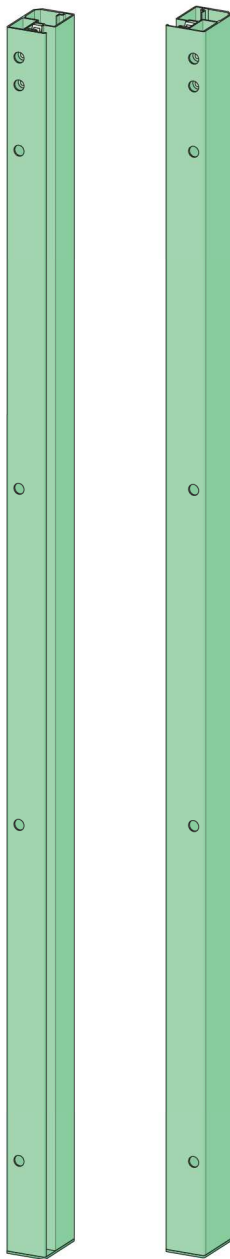
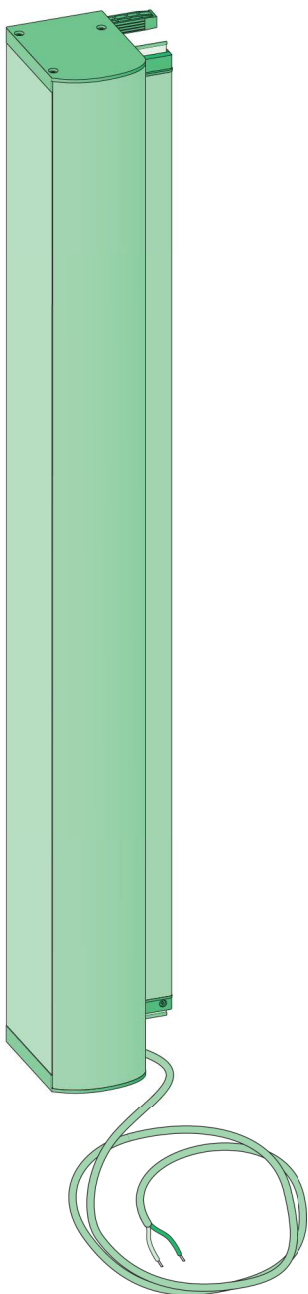
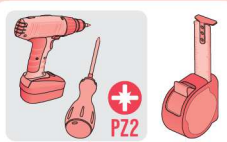

1

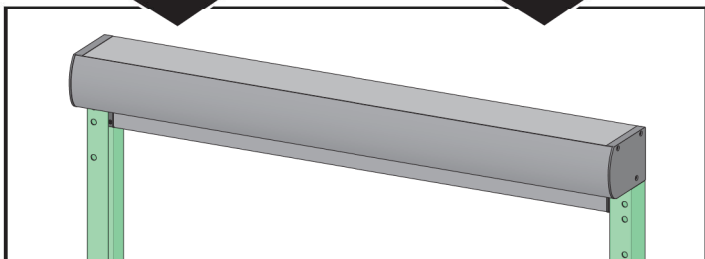
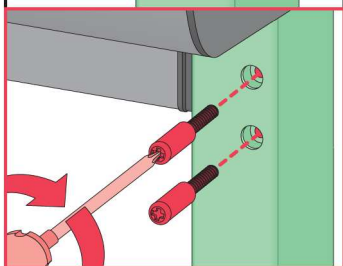
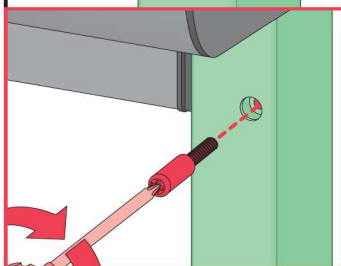
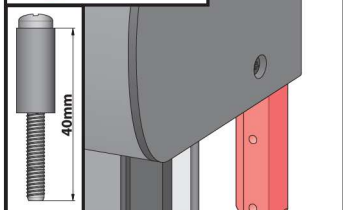
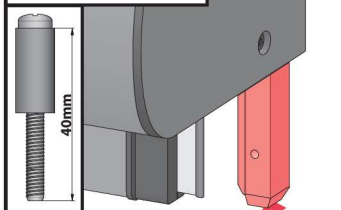
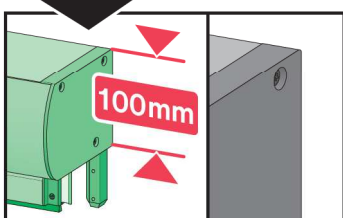
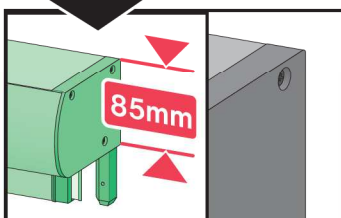
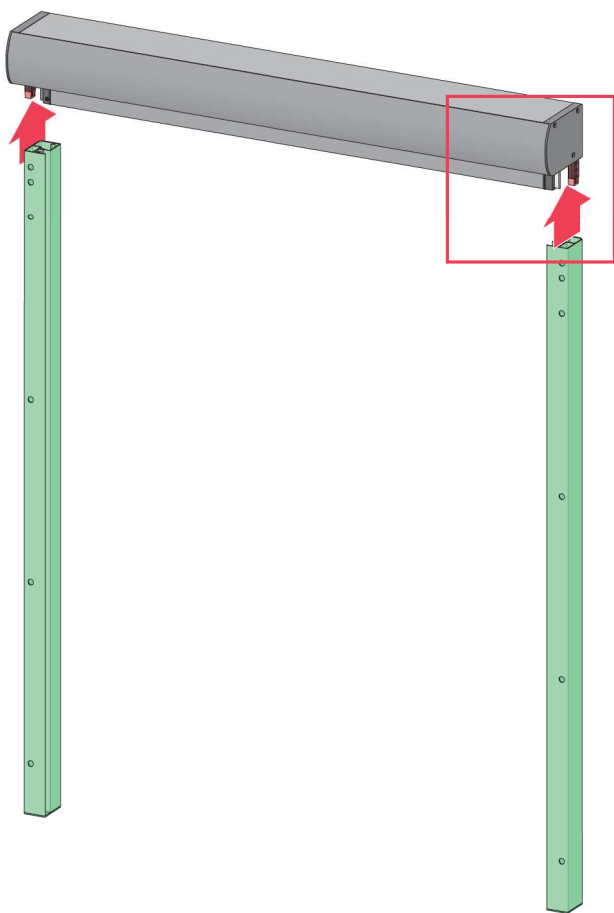

2a

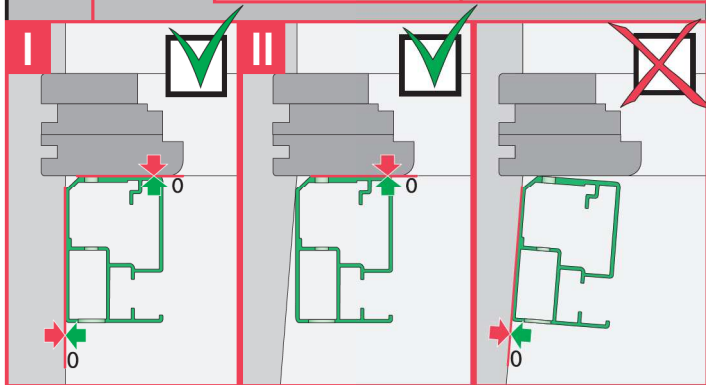
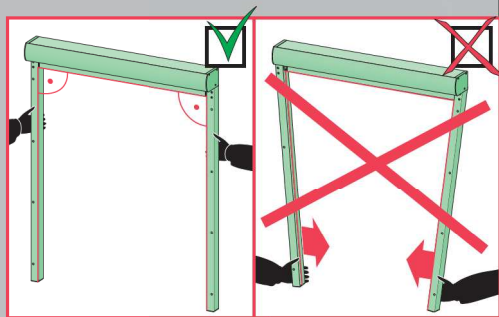
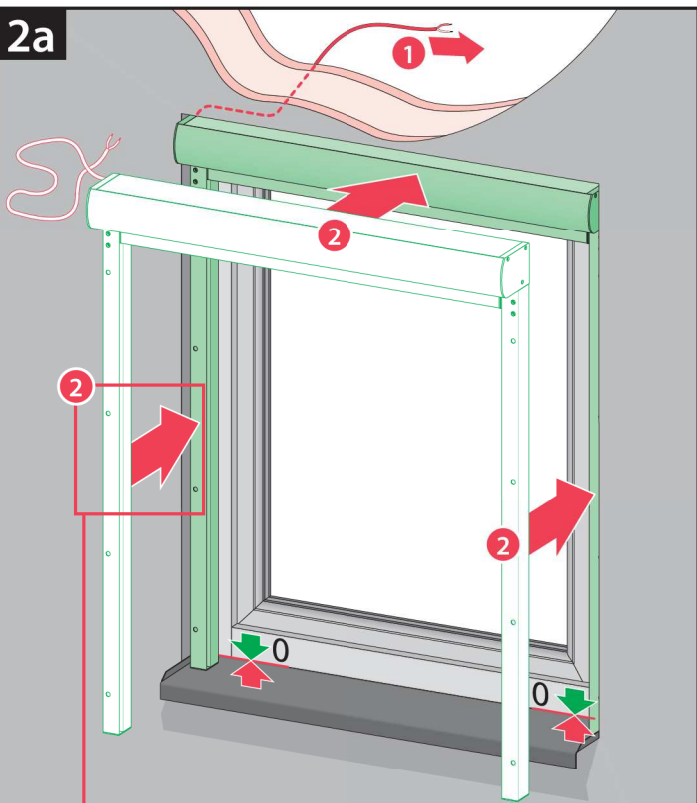

2b

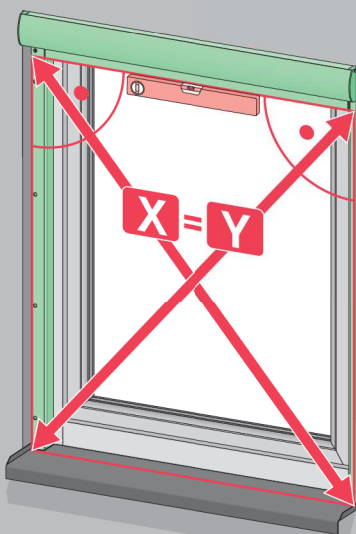

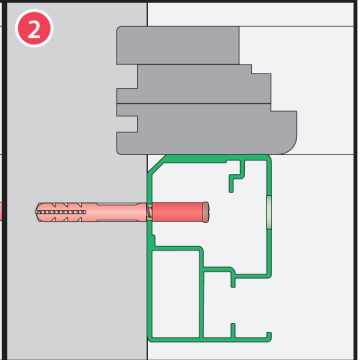
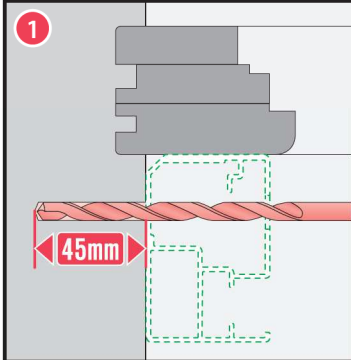
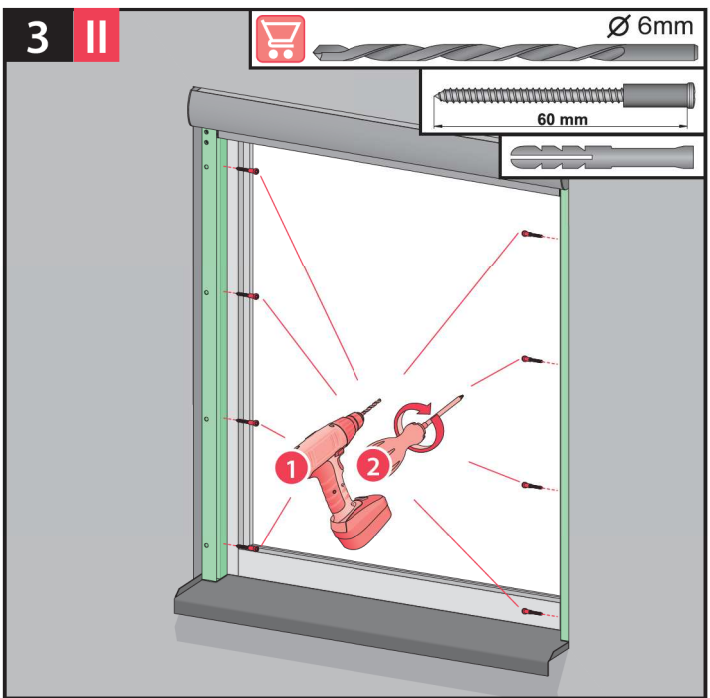
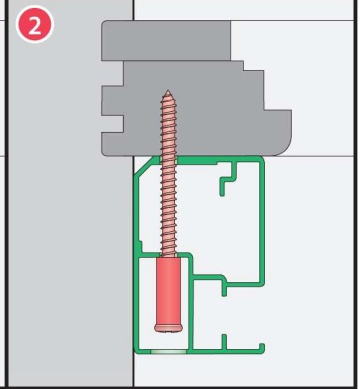
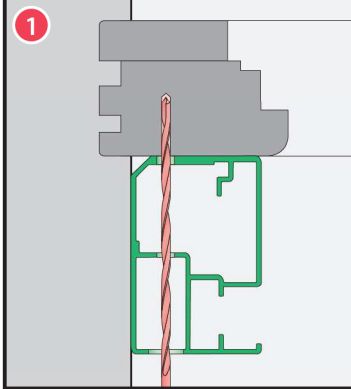
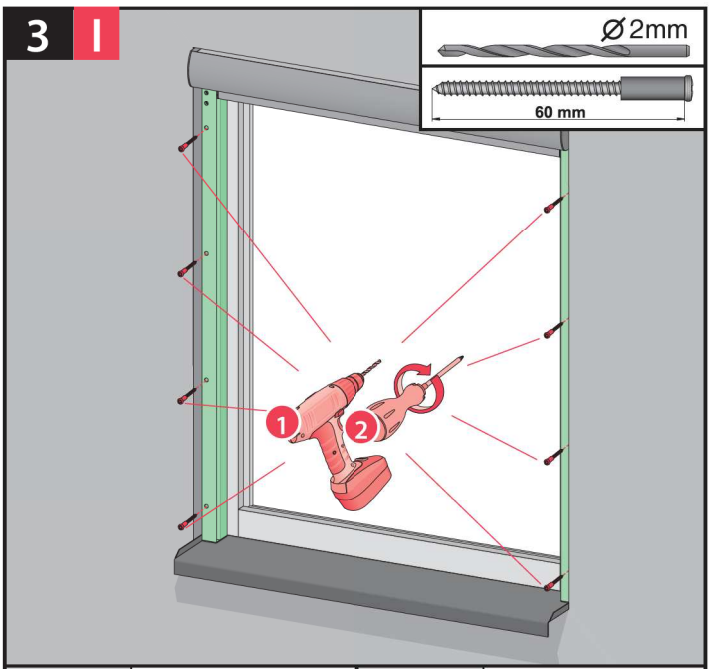

3

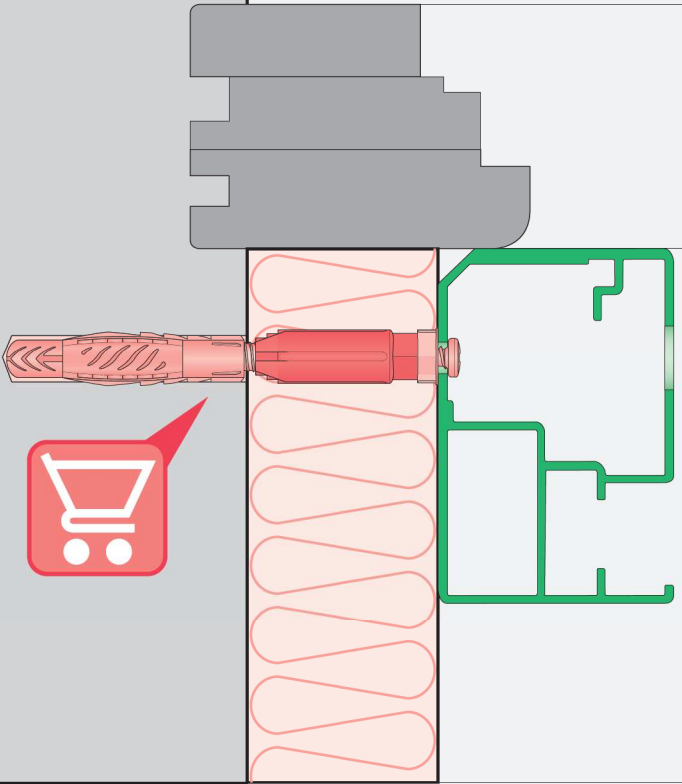

[www.fakro.com/service](http://www.fakro.com/service)

4

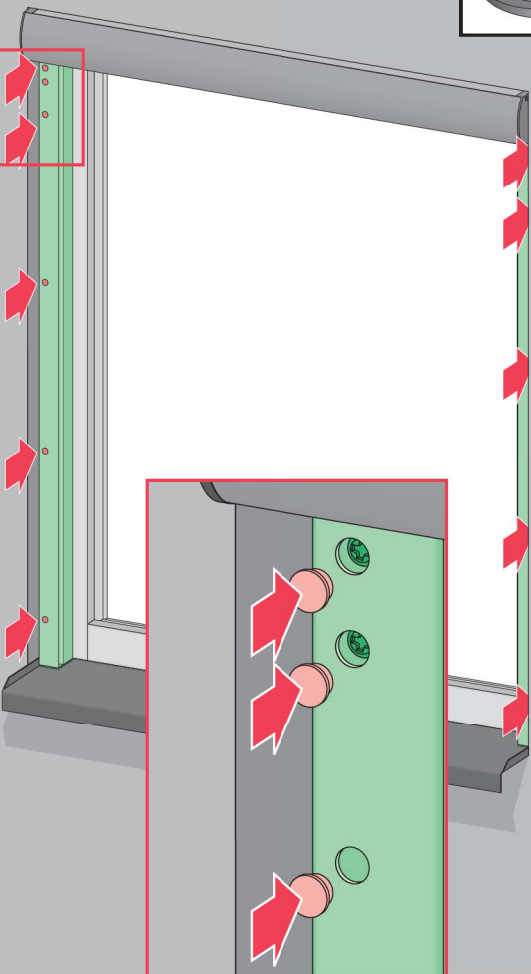
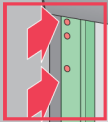
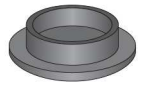

5a

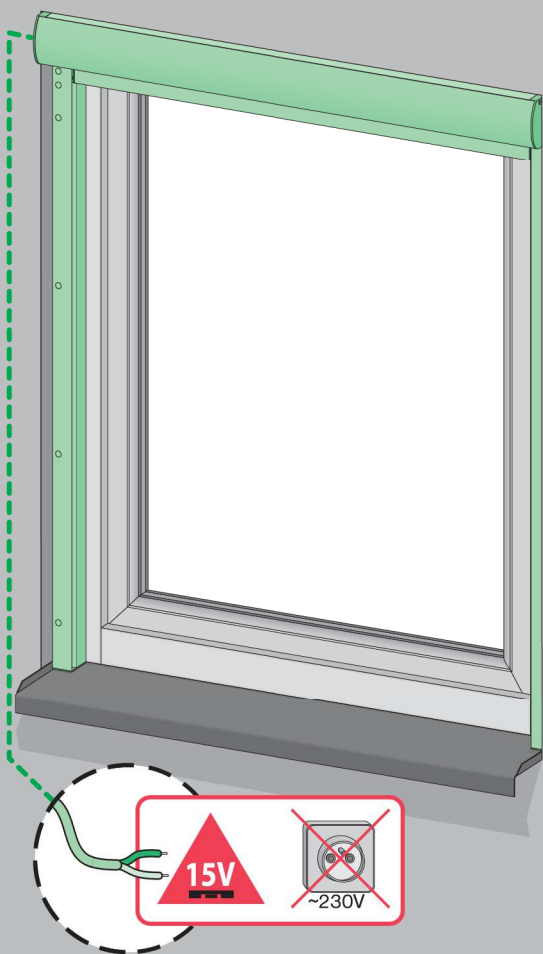

5b

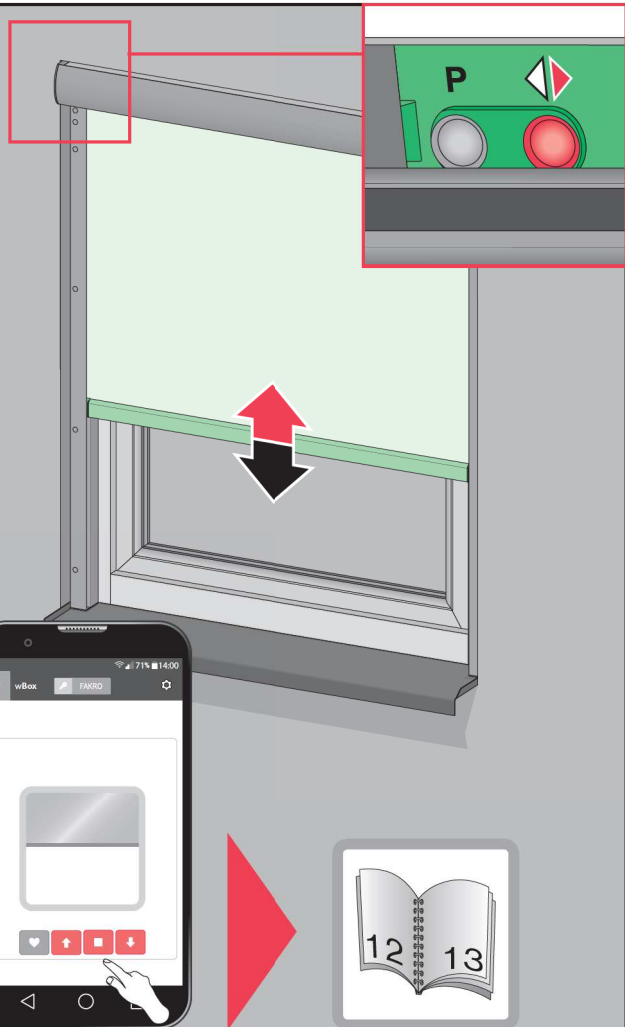

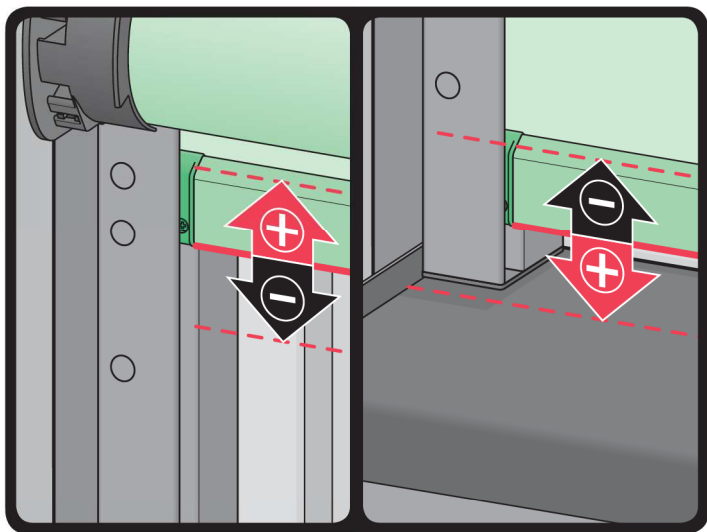

6a

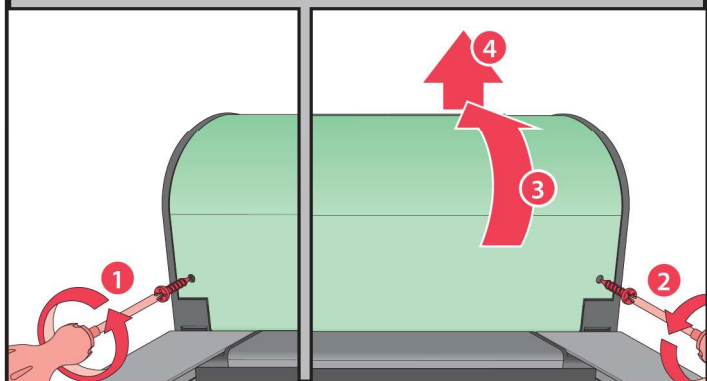
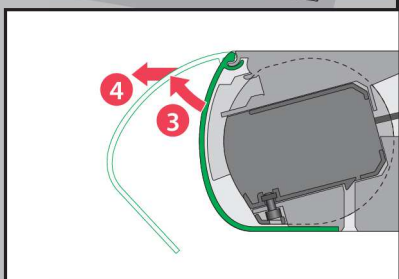
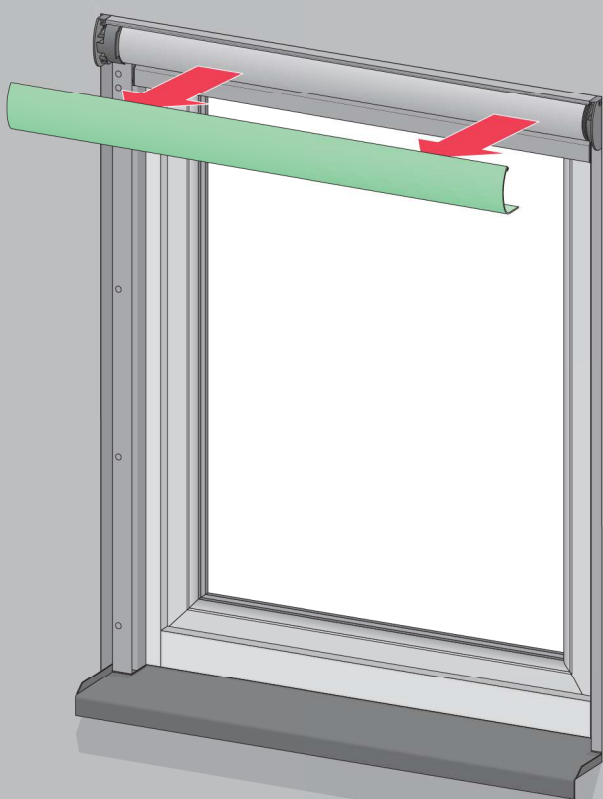



6b

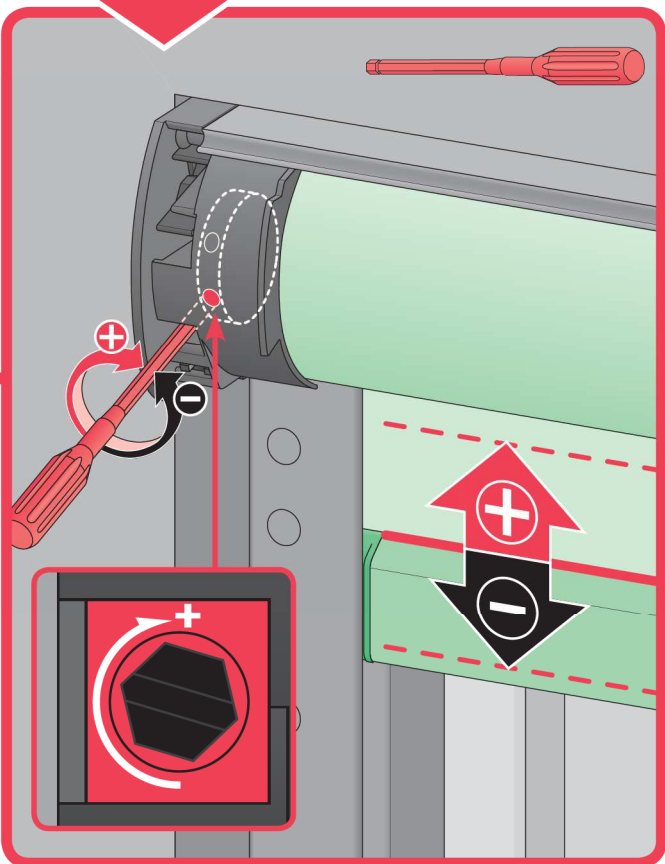
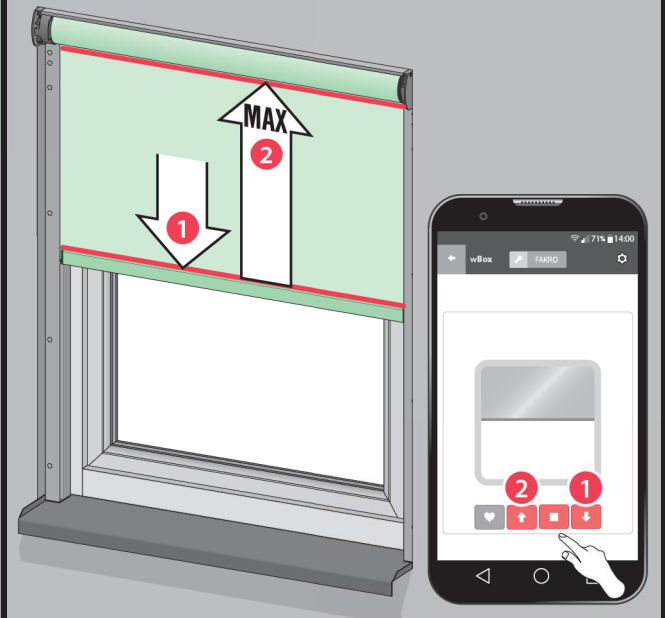

6c

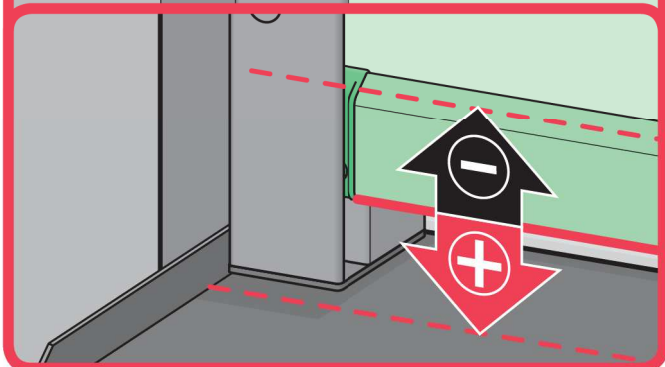
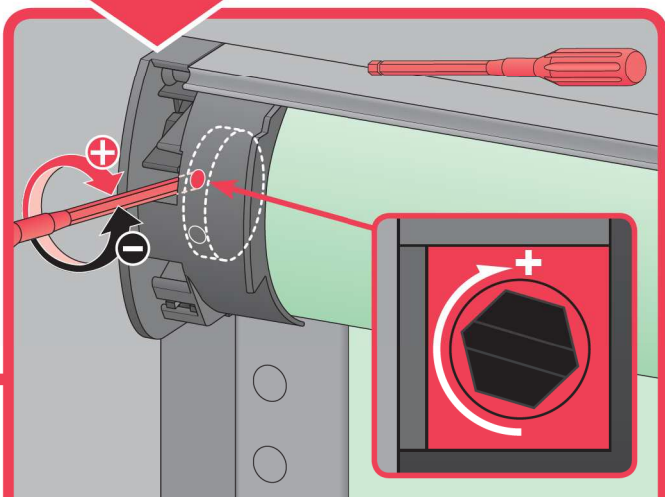
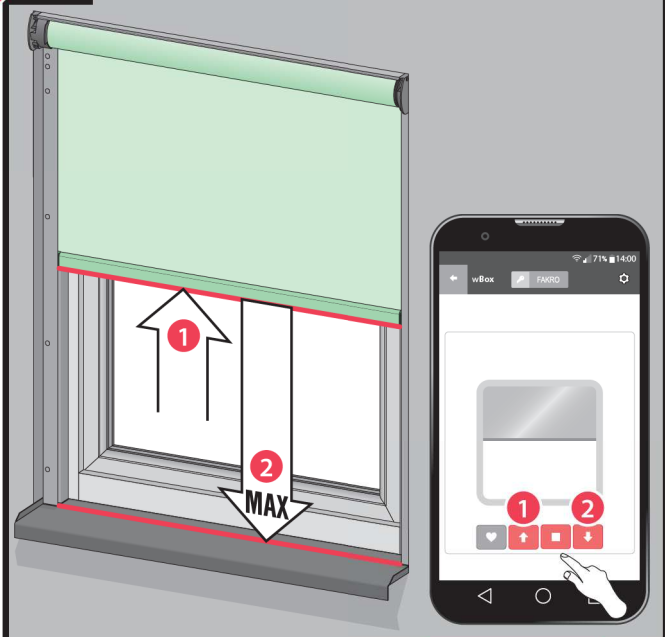

6d

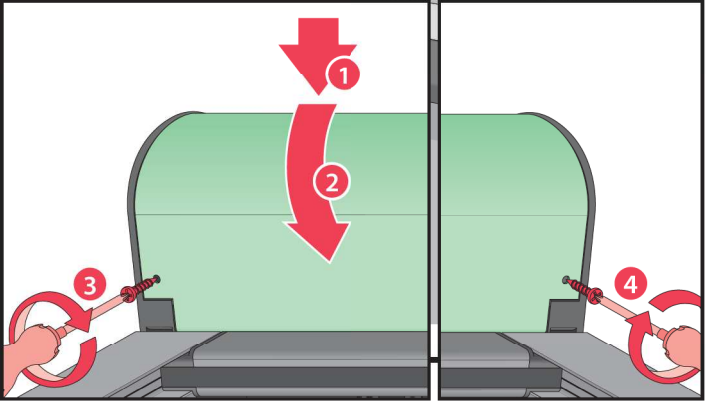
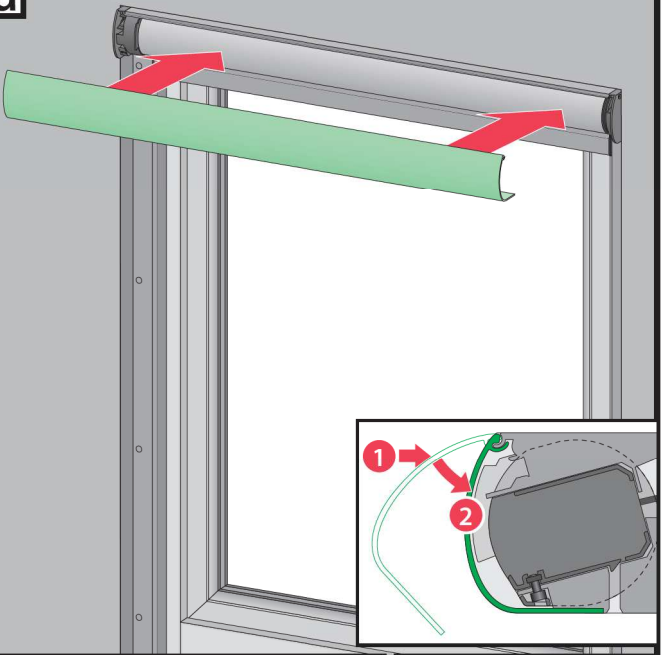

1



wBox  
ANDROID



wBox  
IOS

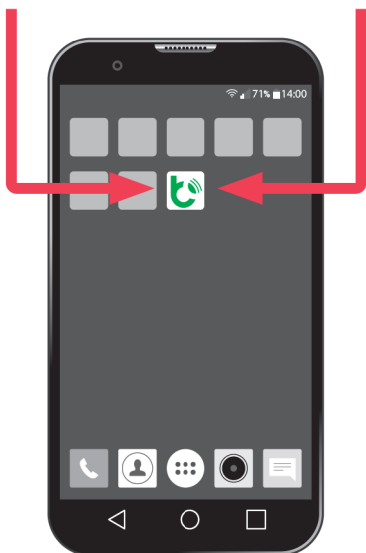

2

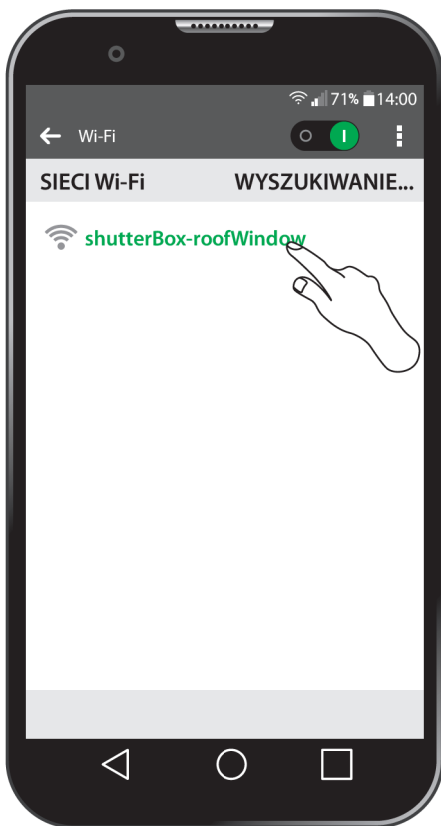

3

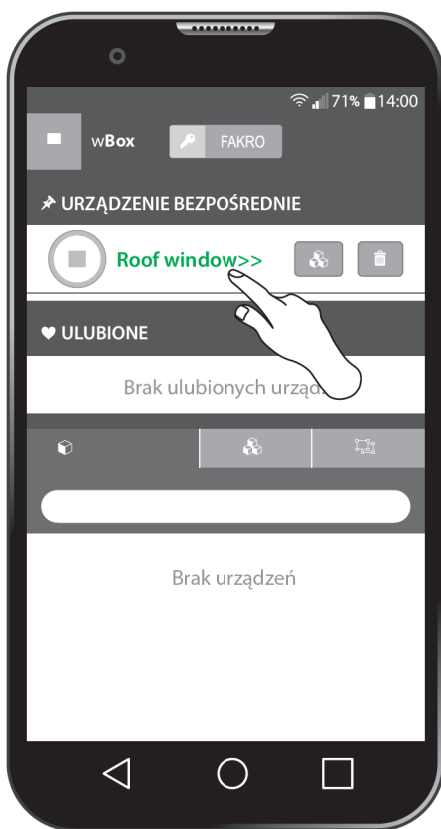

4







<b>PL</b>	Przed montażem należy zapoznać się z treścią instrukcji NC9RX „INSTRUKCJA ORYGINALNA 2/3 Zasady montażu i użytkowania”.
1	Połączyć prowadnice boczne z kasetą markizy.
2a	Umieścić markizę w otworze okiennym.
2b	Sprawdzić poprawność montażu markizy.
3	Przykręcić markizę do okna lub do szpalety.
4	Umieścić zaślepki w otworach prowadnic.
5a	Podłączyć markizę do sieci za pomocą zasilacza 15VDC.
5b	Sterować markizą za pomocą aplikacji wBox lub przycisków na sterowniku.
6a, 6b, 6c, 6d	W razie potrzeby przeprowadzić regulację pozycji krańcowych markizy.

<b>EN</b>	Before installation, it is compulsory to read the NC9RX „ORIGINAL INSTRUCTIONS 2/3 Installation and user manual”.
1	Connect the side guide rails to the awning cassette.
2a	Place the awning in the window opening.
2b	Check the correctness of the awning installation.
3	Screw the awning to the window or to the lining.
4	Place plugs in the guide rails openings.
5a	Connect the awning to the network using the 15VDC power supply.
5b	Operate the awning using the wBox app or button on the controller.
6a, 6b, 6c, 6d	If required, adjust the end positions of the awning.

<b>CZ</b>	Před montáží si pozorně přečtěte návod NC9RX „ORIGINÁLNÍ NÁVOD 2/3 Pravidla pro instalaci a použití”.
1	Spojte boční vodičí lišty s kasetou markízy.
2a	Umístěte markízu do okenního otvoru.
2b	Zkontrolujte správnost montáže markízy.
3	Přišroubujte markízu k oknu nebo k ostění.
4	Vložte záslepky do otvorů vodičích lišt.
5a	Připojte markízu do el. sítě pomocí napájecího zdroje 15 V DC.
5b	Ovládejte markízu pomocí aplikace wBox nebo ovládacího tlačítka.
6a, 6b, 6c, 6d	V případě potřeby proveďte regulaci koncových poloh markízy.

**CZ** Výrobce ani prodejce nenesou žádnou odpovědnost za nedodržení příslušných platných zákonů, stavebních předpisů a bezpečnostních požadavků uživatelem výrobku, architektem, montážníkem nebo vlastníkem budovy.

**DE** Hersteller und Verkäufer übernehmen keine Haftung für Nichtbeachtung entsprechender Rechts- und Bauvorschriften sowie Sicherheitsanforderungen seitens Produktbenutzers, Architekten, Monteure oder Gebäudebesitzers.

**ES** El fabricante y el vendedor no tienen ninguna responsabilidad por el incumplimiento de la ley vigente, normas de construcción y exigencias de seguridad por parte del usuario del producto, arquitecto, instalador o el propietario del edificio.

**FR** Le fabricant et le revendeur ne prend aucune responsabilité de ne pas respecter les lois applicables, les règlements sur les bâtiments et les exigences de sécurité par l'utilisateur du produit, l'architecte, l'installateur ou le propriétaire du bâtiment.

**GB** Manufacturer and Seller shall bear no liability for failure to comply with the applicable laws, building codes and safety requirements by the user of the product, architect, fitter or owner of the building.

**HU** A Gyártó és a Forgalmazó nem vállal semmiféle felelősséget a vonatkozó törvényi, építési és biztonsági előírások termékfelhasználó, építész, beépítőmester vagy épülettulajdonos általi be nem tartásáért.

**IT** Il Produttore e il Rivenditore non potranno essere ritenuti responsabili per il mancato rispetto, da parte dell'utente del prodotto, del progettista, dell'installatore o del proprietario dell'edificio, delle leggi vigenti, nonché dei regolamenti edilizi e di quelli

**NL** De fabrikant en verkoper zijn niet aansprakelijk voor gevolgen bij het niet opvolgen van toepasselijke wetten, bouwbesluiten en veiligheidsvoorschriften door de gebruiker van het product, de architect, de installateur of de eigenaar van het gebouw.

**PL** Producent i Sprzedawca nie ponosi żadnej odpowiedzialności za nieprzestrzeganie stosownych przepisów prawa, przepisów budowlanych i wymogów bezpieczeństwa przez użytkownika produktu, architekta, montażystę lub właściciela budynku.

**PT** O fabricante e o vendedor não tem nenhuma responsabilidade pelo o não cumprimento da lei, códigos de construção e as exigências de segurança por parte do usuário do produto, arquiteto, instalador ou proprietário do edifício.

**RO** Nici producătorul, nici distribuitorul nu își vor asuma niciun fel de răspundere pentru nerespectarea legilor în vigoare, a legilor din domeniul construcțiilor sau a măsurilor de siguranță impuse utilizatorilor produsului, arhitecților, montajorilor sau proprietarilor clădirii.

**RU** В случае несоблюдения архитектором, монтажником или владельцем здания строительных правил и норм безопасности ответственность с производителя и продавца снимается.

**SK** Výrobca a predajca nenesú žiadnu zodpovednosť za nedodržanie príslušných ustanovení zákona, stavebných predpisov a bezpečnostných požiadaviek užívateľom výrobku, architektom, montérom alebo majiteľom objektu.