

APS/APF

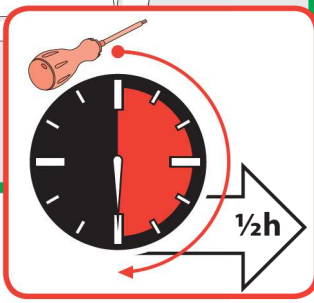

NC 9FF 100/APS, APF/07.11.2018/F

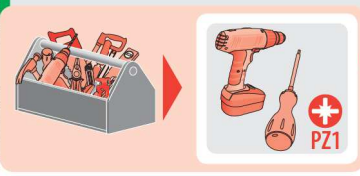

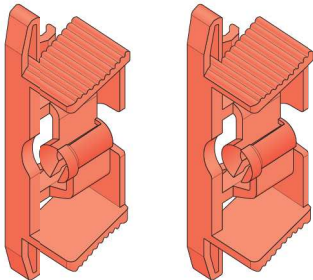
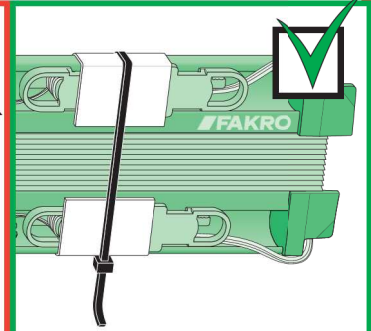
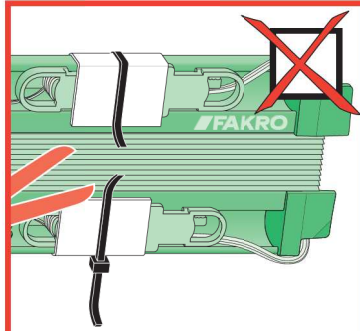
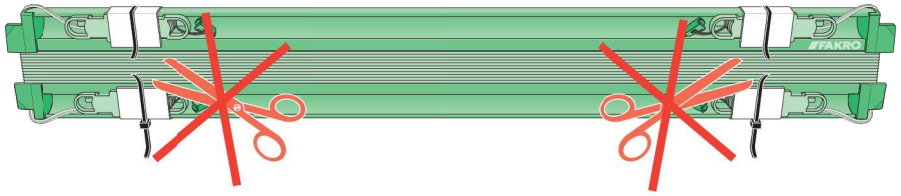

1

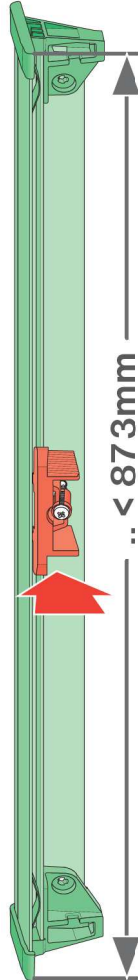
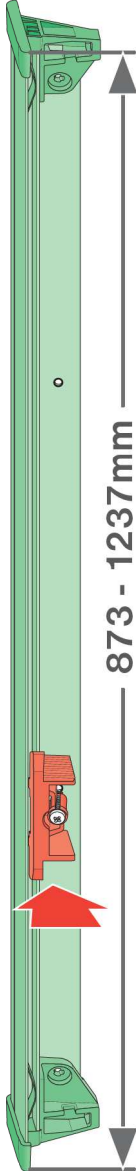
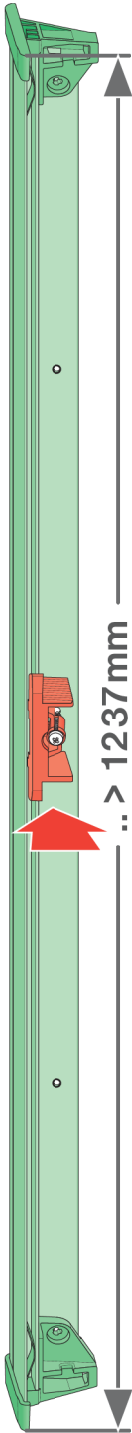
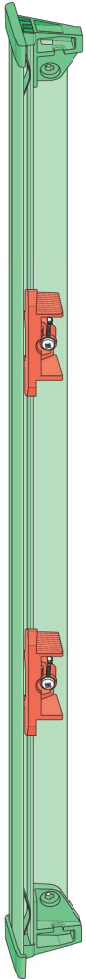

1

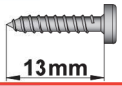
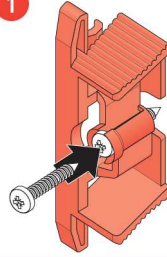

2

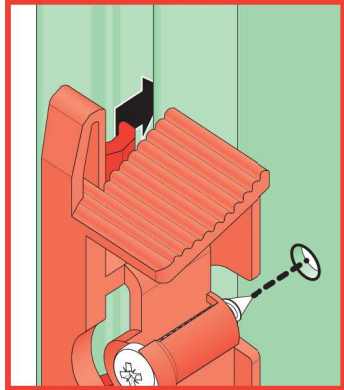
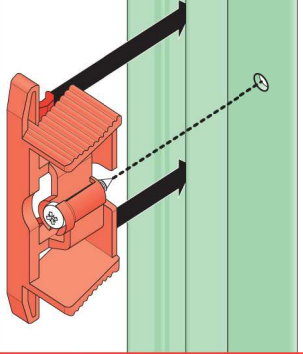

3

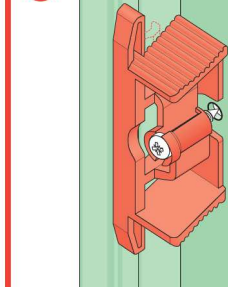

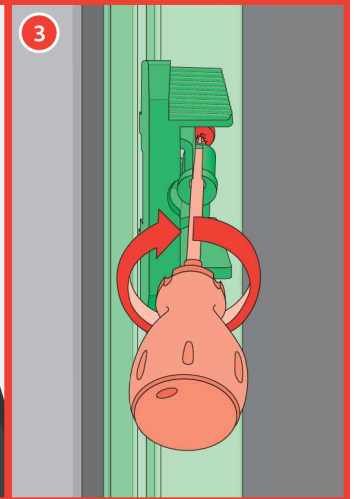
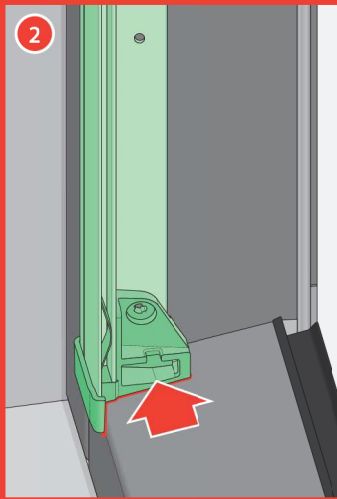
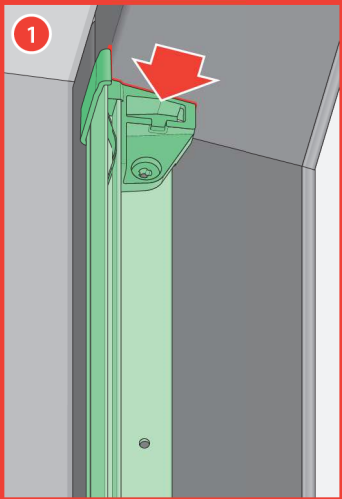
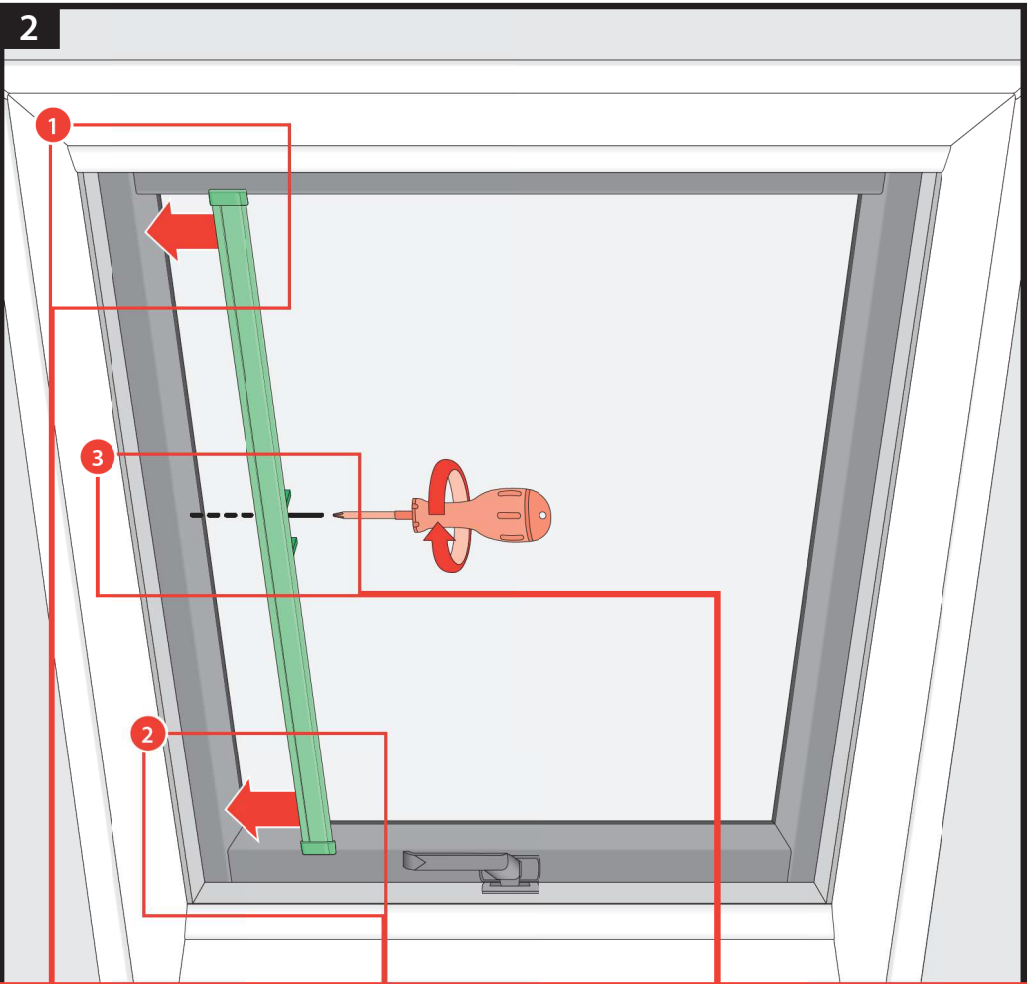

3

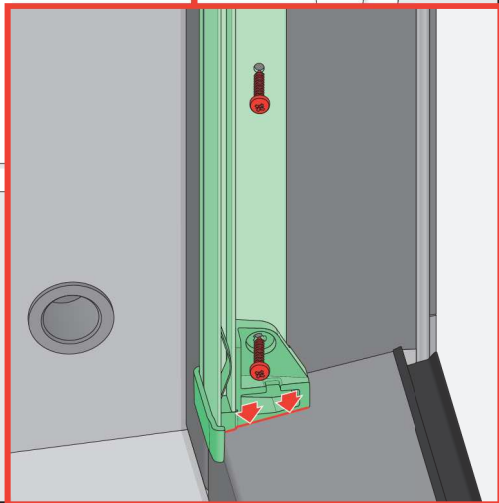
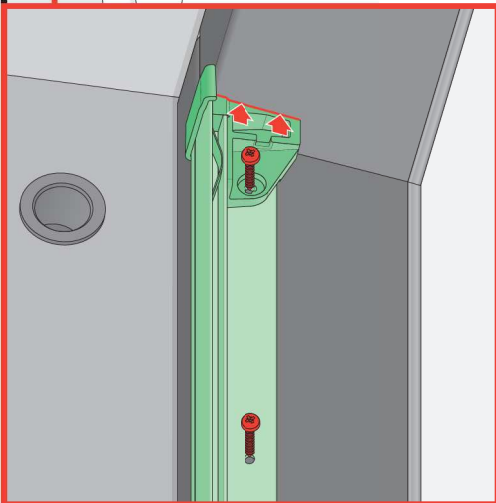
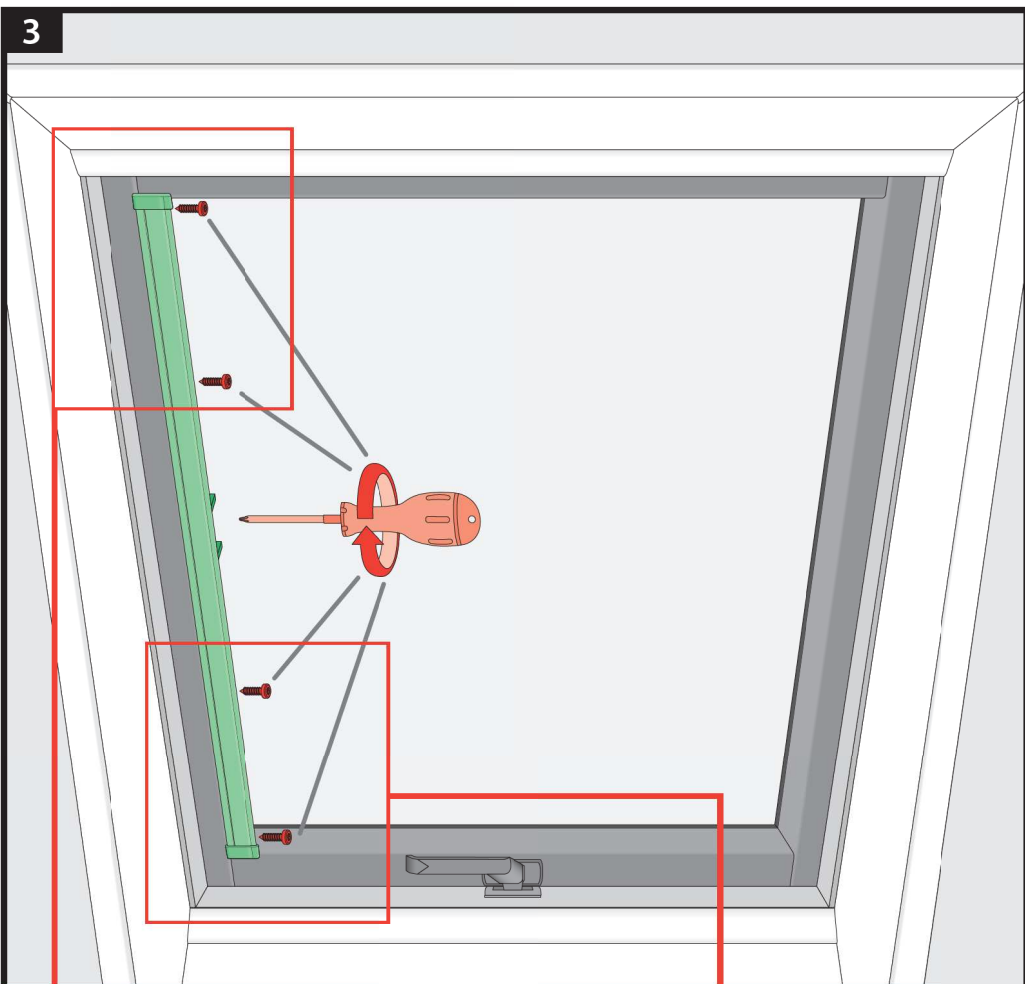

5

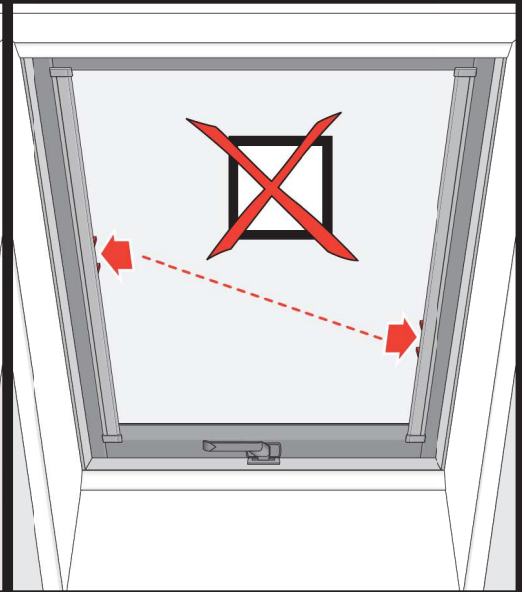
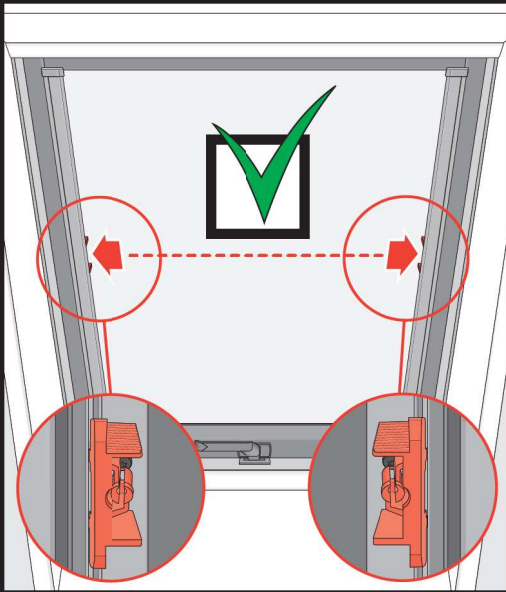
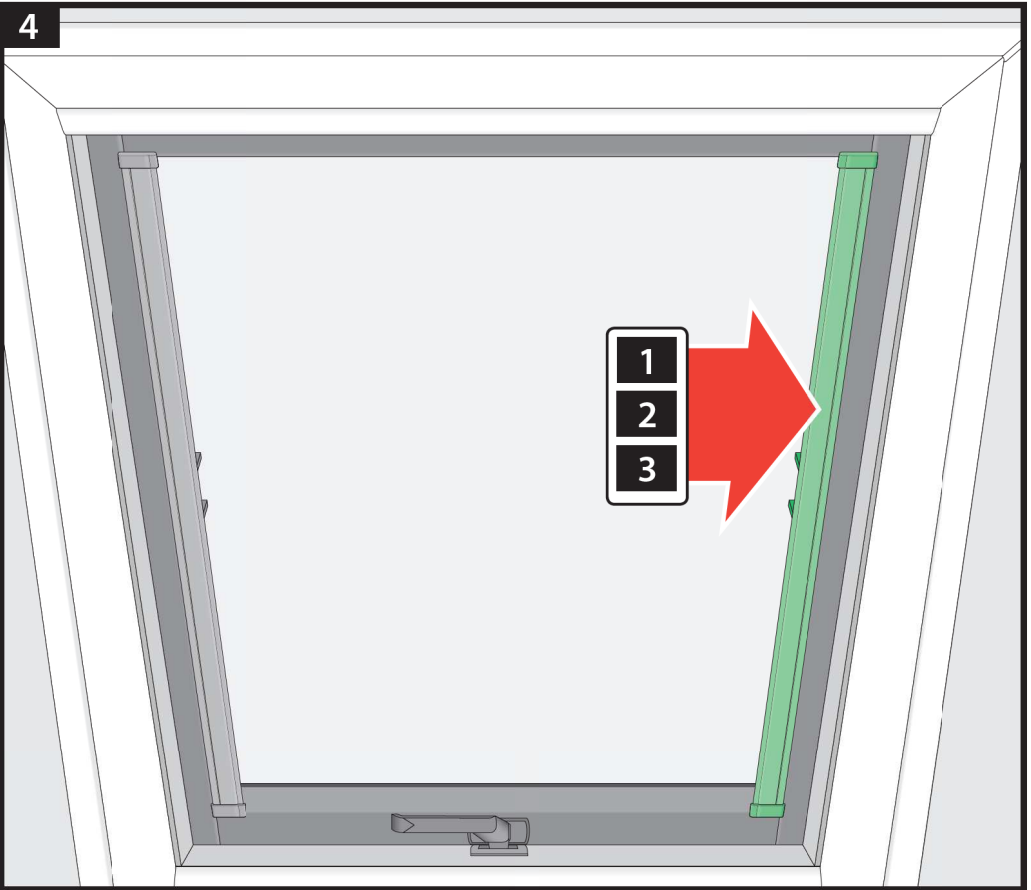

5

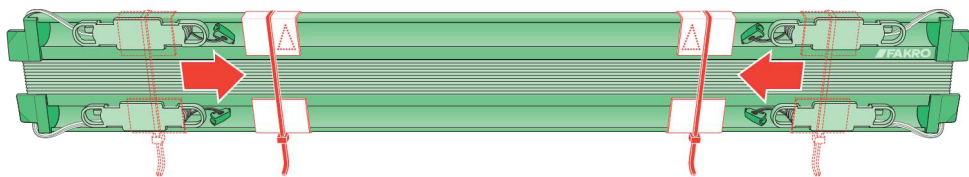

6

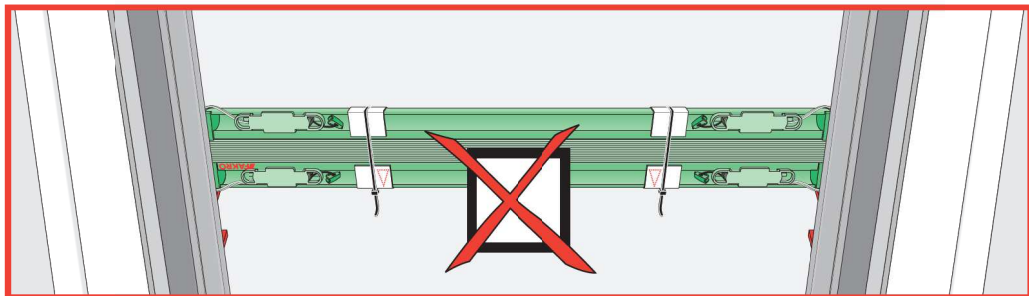
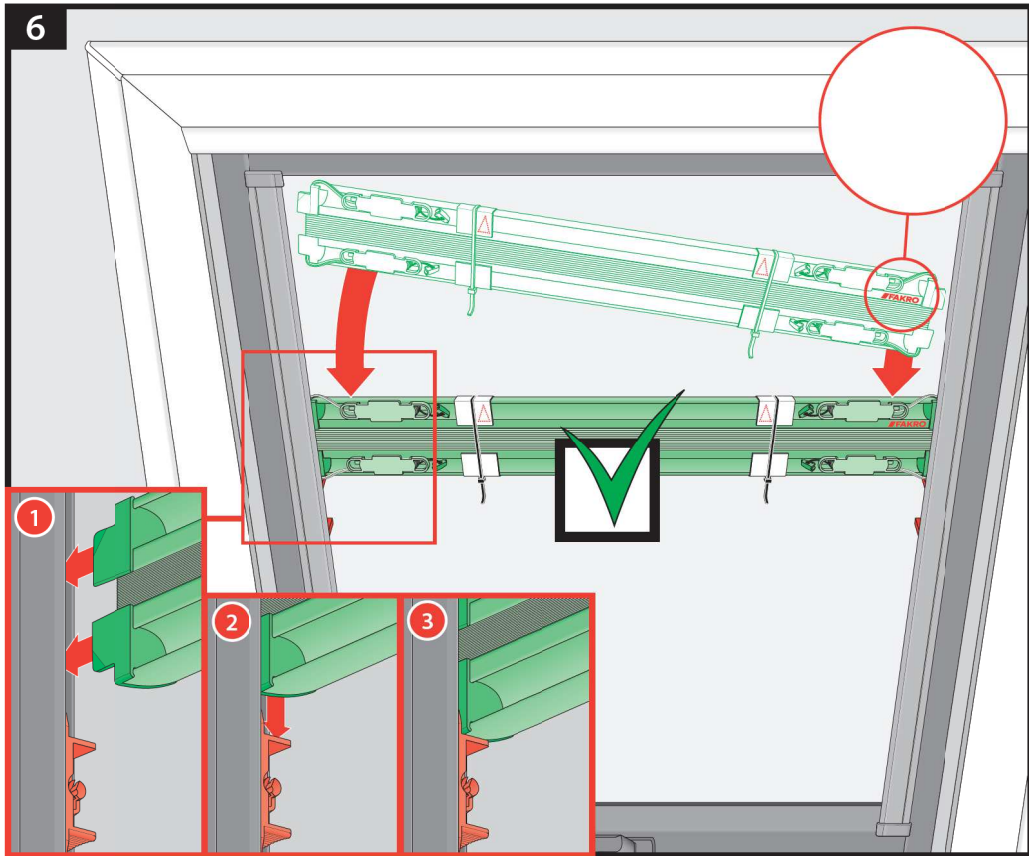

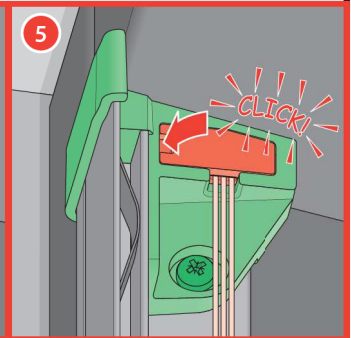
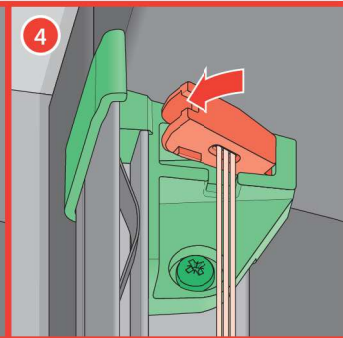
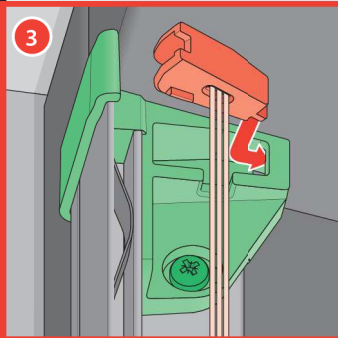
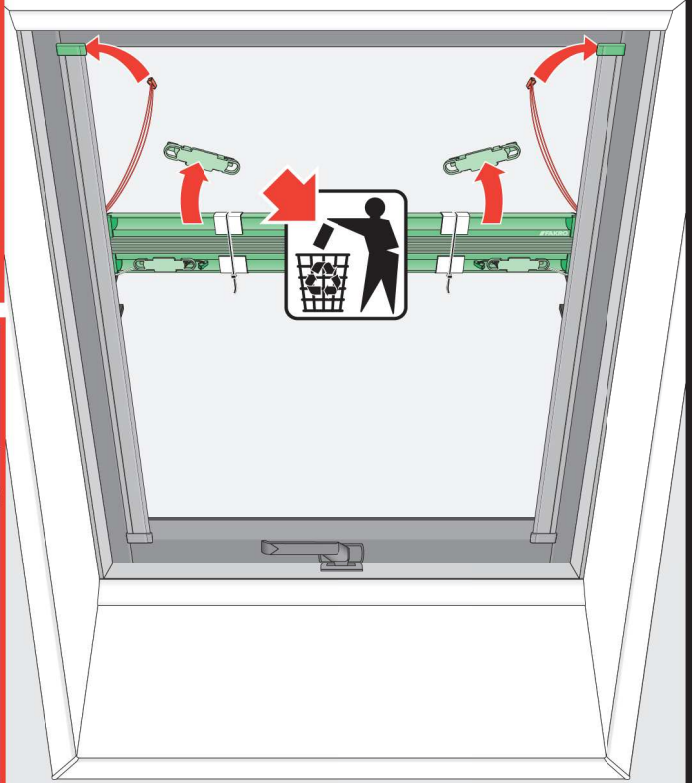
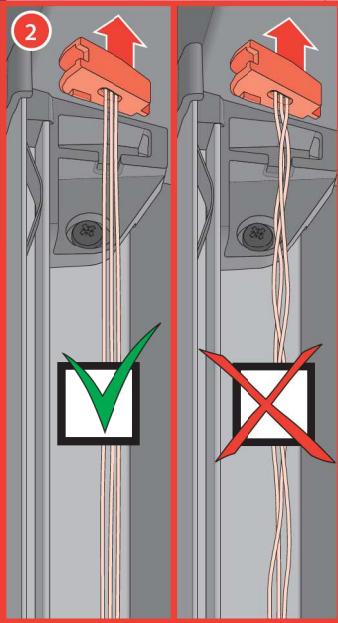
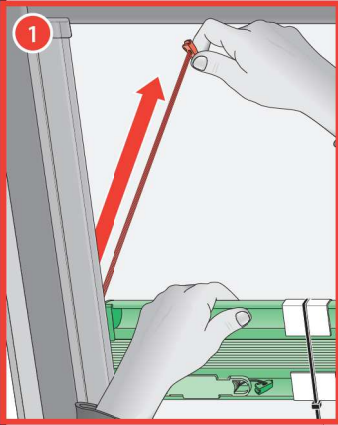

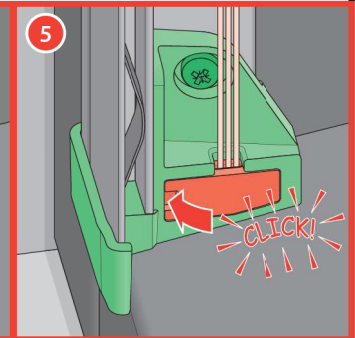
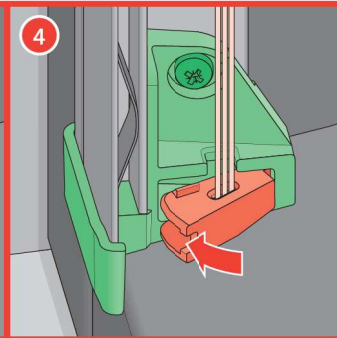
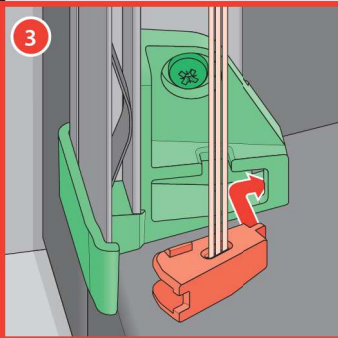
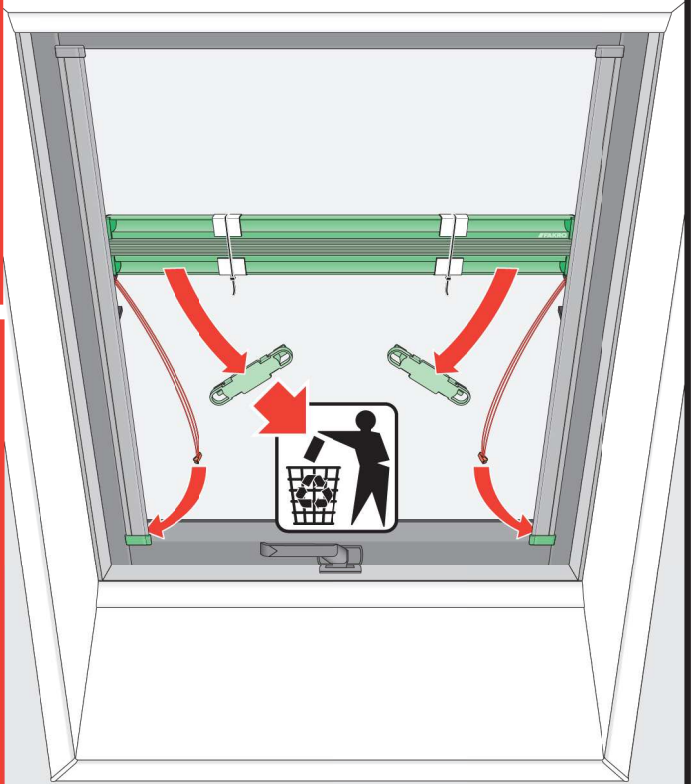
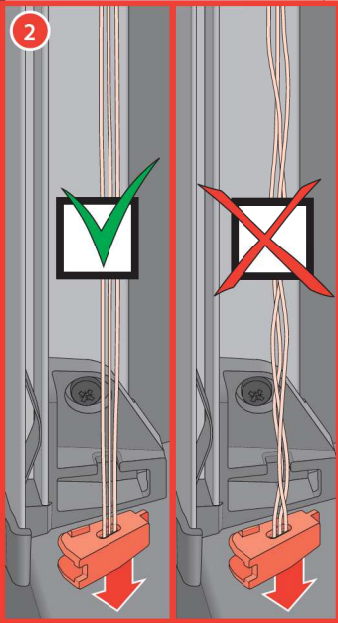
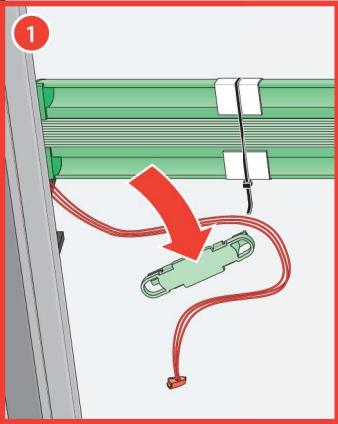

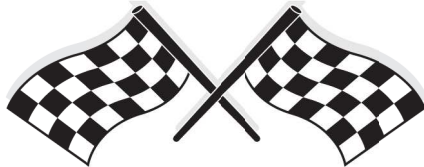
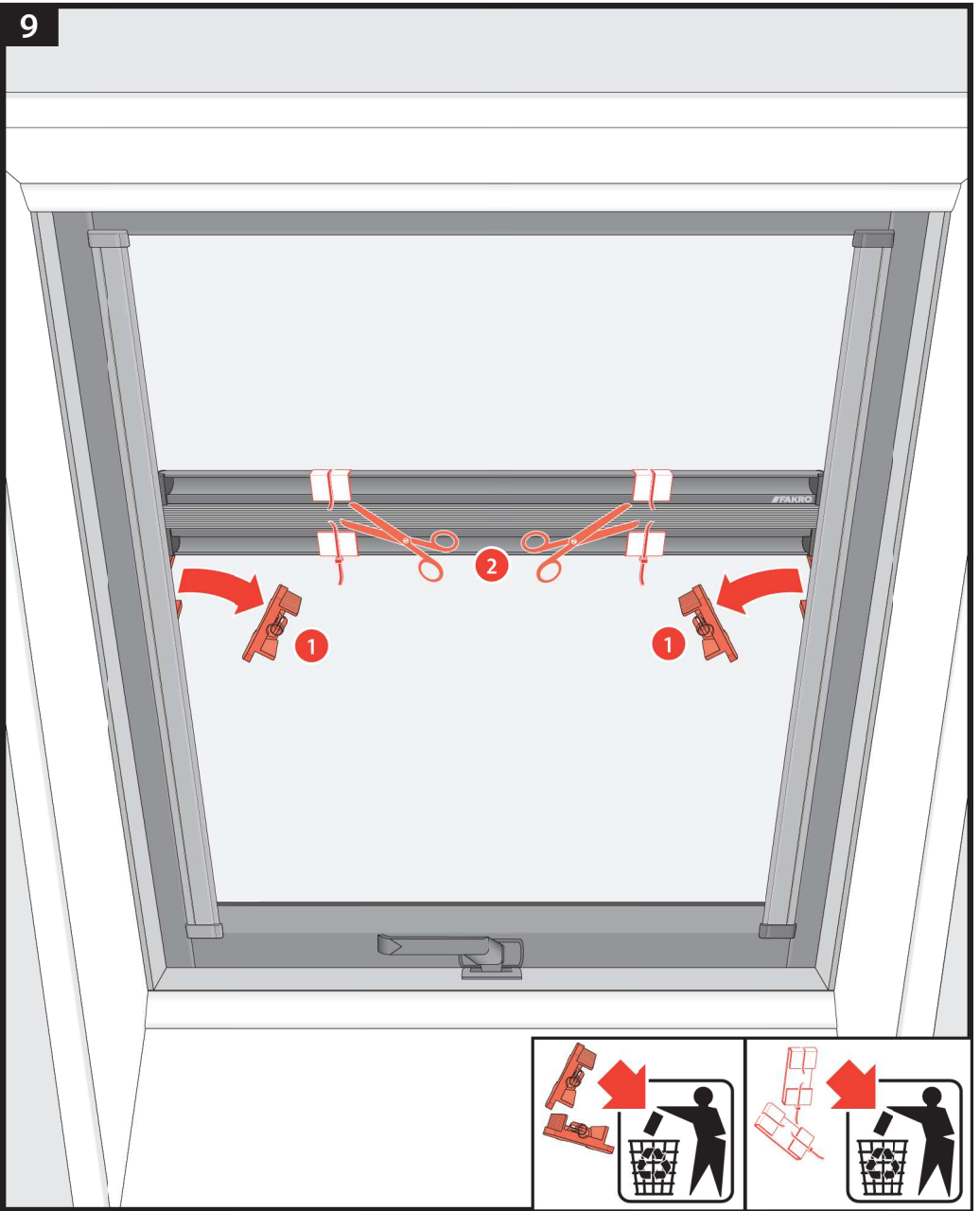

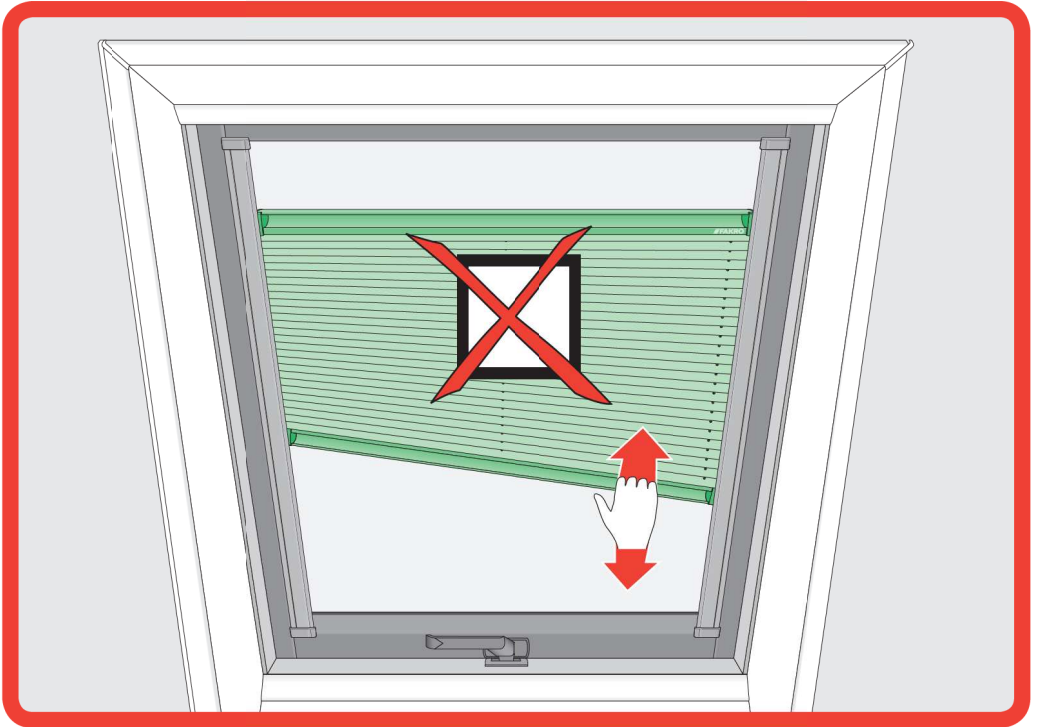
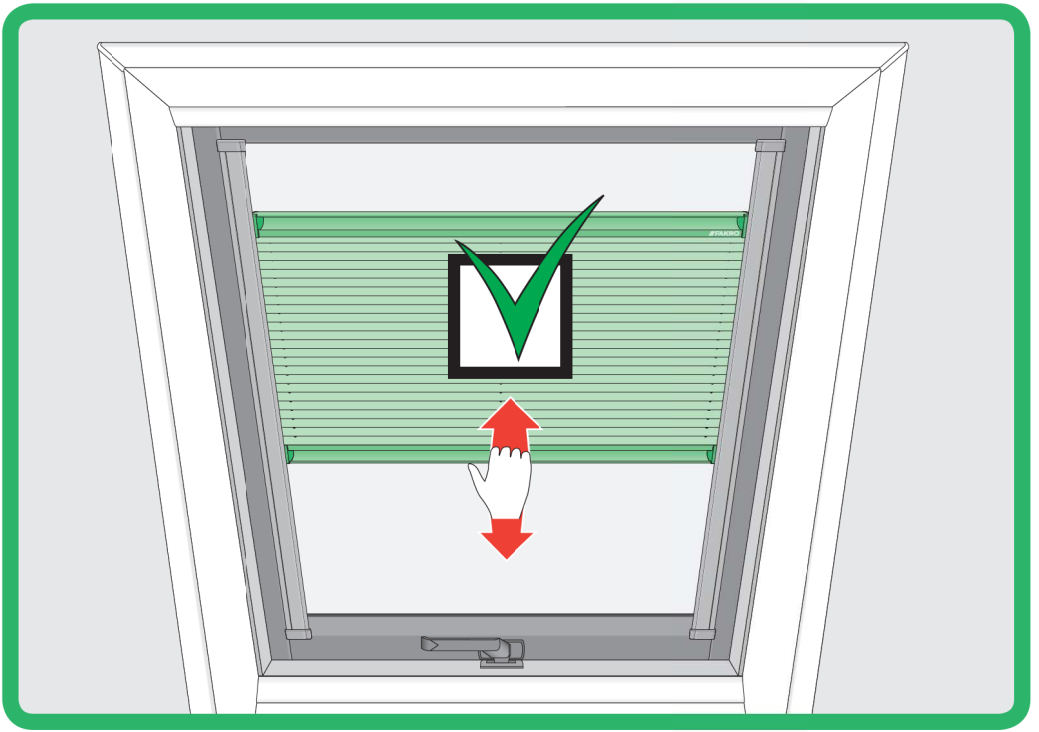



0 [cm] 1 2 3 4 5 6 7 8 9 10 11 12 13 14

| | | | |
|-----------|--|-----------|--|
| CZ | Výrobce ani prodejce nenesou žádnou odpovědnost za nedodržení příslušných platných zákonů, stavebních předpisů a bezpečnostních požadavků uživatelem výrobku, architektem, montážníkem nebo vlastníkem budovy. | DE | Hersteller und Verkäufer übernehmen keine Haftung für Nichtbeachtung entsprechender rechts- u. n. Bauvorschriften sowie Sicherheitsanforderungen seitens Produktbenutzers, Architekten, Monteurs oder Gebäudebesitzer. |
| ES | El fabricante y el vendedor no tienen ninguna responsabilidad por el incumplimiento de la ley vigente, normas de construcción y exigencias de seguridad por parte de usuario del producto, arquitecto, instalador o el propietario del edificio. | FR | Le fabricant et le vendeur ne prend aucune responsabilité de ne pas respecter les lois applicables, les règlements sur les bâtiments et les exigences de sécurité par l'utilisateur du produit, l'architecte, l'installateur ou le propriétaire du bâtiment. |
| GB | Manufacturer and Seller shall bear no liability for failure to comply with the applicable laws, building codes and safety requirements by the user of the product, architect, fitter or owner of the building. | HU | A Gyártó és a Forgalmazó nem vállal semmiféle felelősséget a vonatkozó törvényi, építési és biztonsági előírások, terméktechnikai, építész, vezetőmester vagy épületudvarosok által be nem tartásáért. |
| IT | Il Produttore e il Rivenditore non potranno essere ritenuti responsabili per il mancato rispetto, da parte dell'utente del prodotto, del progettista, dell'installatore o del proprietario dell'edificio, delle leggi vigenti, nonché dei regolamenti edilizi e di quelli relativi alla sicurezza. | NL | De fabrikant en verkoper zijn niet aansprakelijk voor gevolgen bij het niet opvolgen van toepasselijke wettelijke, bouwbesluit en veiligheidsvoorschriften door de gebruiker van het product, de architect, de installateur of de eigenaar van het gebouw. |
| PL | Producent i Sprzedawca nie ponosi żadnej odpowiedzialności za nieprzestrzeganie stosownych przepisów prawa, przepisów budowlanych i wymogów bezpieczeństwa przez użytkownika produktu, architekta, montażystę lub właściciela budynku. | PT | O fabricante e o vendedor não tem nenhuma responsabilidade pelo o não cumprimento da lei, códigos de construção e as exigências de segurança por parte do usuário do produto, arquiteto, instalador ou proprietário do edifício. |
| RO | Nici producătorul, nici distribuitorul nu sîi vor asuma niciun fel de răspundere pentru nerespectarea legilor în vigoare, a legilor din domeniul construcțiilor sau a măsurilor de siguranță impuse utilizator produsului, arhitectului, montajistului sau proprietarilor clădirii. | RU | В случае несоблюдения архитектором, монтажником или владельцем здания строительных правил и норм безопасности ответственность с производителя и продавца снимается. |
| SK | Výrobca a predávka nenesú žiadnu zodpovednosť za neobdržanie príslušných ustanovení zákona, stavebných predpisov a bezpečnostných požadaviek užívateľom výrobku, architektom, montérom alebo majiteľom objektu. | | |